

Product description

Pogo pin is generally used in mobile phones, communications, automotive, medical, aerospace and other electronic products in the precise connection, can improve the anti-corrosion, stability, durability of these connectors. As for the needle tips, sharp header, grasping needle, round-headed needle, knife-shaped needle and so on are welcomed to customize.

Product specifications

Item number	SF5977
Full stroke	3.0mm
Rated stroke	2.0mm
Spring force	80±10gf@ load 2.0mm
MOQ	200PCS
Package	Plastic bag, carton box
Payment	T/T
Delivery time	5-10days after receiving the payment

Product Pictures

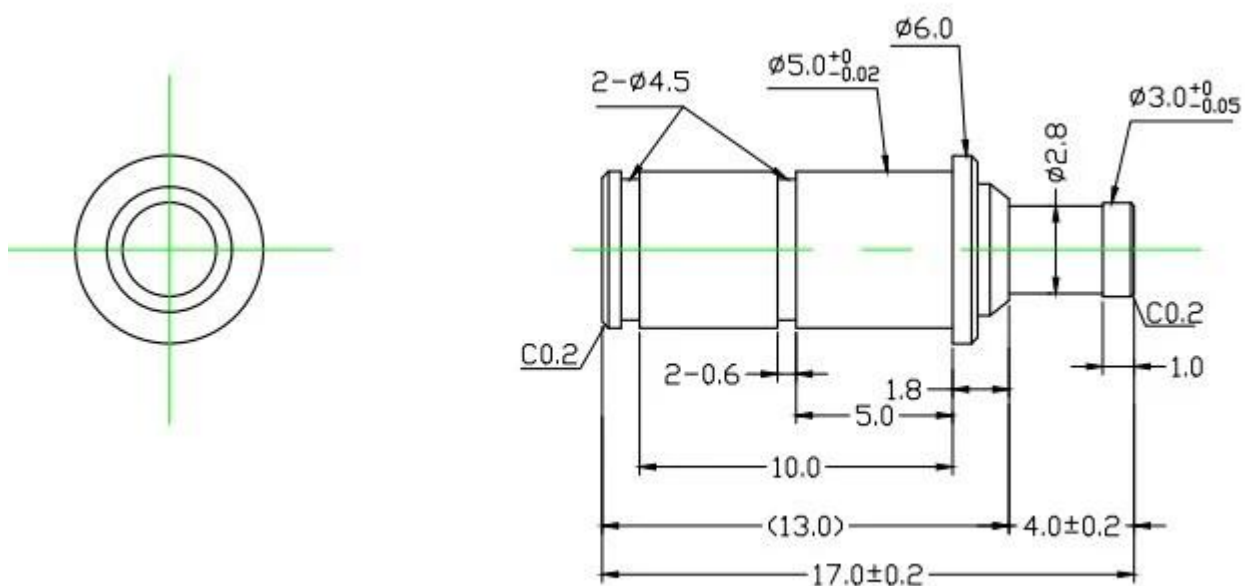

Production Flow



1. raw material warehouse



2. Lathe workshop



3. Assemble workshop



4. Quality inspection



5. Finished products



6. Packing

Testing Equipment

Measuring Equipment >

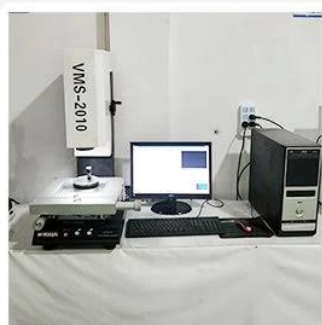

Measuring Equipment:

1. Agilent current testing;
2. Quadratic element measurement
3. Load Curve Meter
4. Bond Test
5. Life Fatigue Test

Packing



Main products

- 1.Spring loaded pin(single)for PCB,ICT,FCTtesting etc;
- 2.Pogo pin(connector)to establish connection between two printed circuit boards for charging,locating,battery,semiconductor&interconnector applications;
- 3.Double ended probes for BGA and semiconductor testing;
- 4.Universal pin without spring,coating pin,LM pin with QZ and VZ series;
- 5.High current probe,switch probe,capacitance needle;
- 6.Terminal&receptacle/socket;
- 7.Other related electronic components,Jig locks,POM and etc.

Whatever you want,please contact us without hesitation ,and we will try our best to meet your requirement within our capability.

Our service

- 1.We can reply your inquiry within 24 working hours;
- 2.Customized design is available and OEM are welcomed;
- 3.We can deliver the probe pins to our clients all over the world with speed and precision.
- 4.We can provide the lowest price with high quality products to our clients.